

PANEL CUTOUT  
MAX. PANEL THICKNESS  
11.0mm [.433]

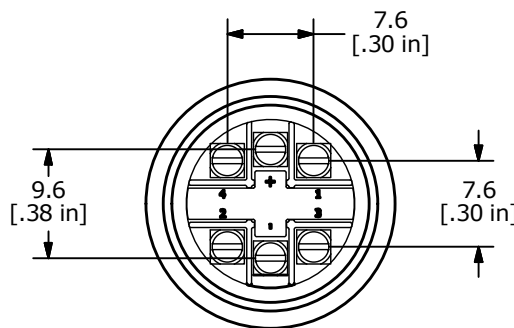

SWITCH FUNCTION	
POS. 1	POS. 2
1-2 ON 3-4 OFF	1-2 (OFF) 3-4 (ON)

( ) = MOMENTARY

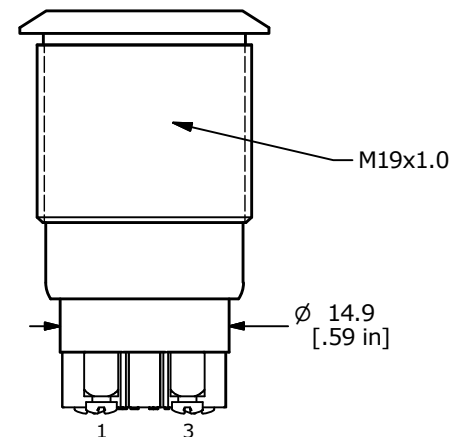
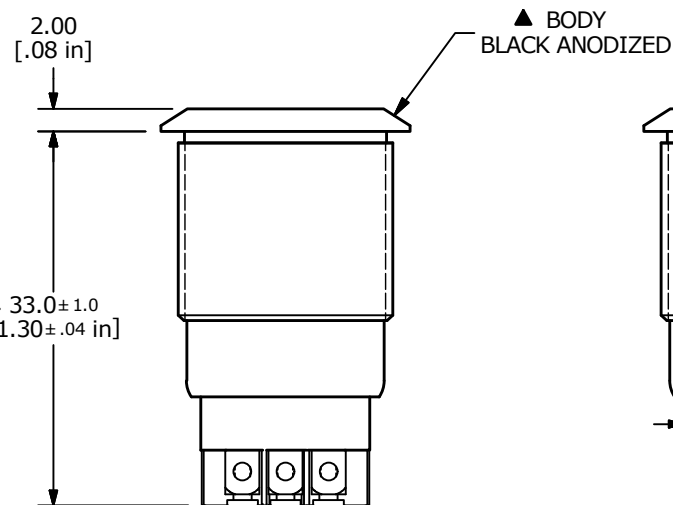
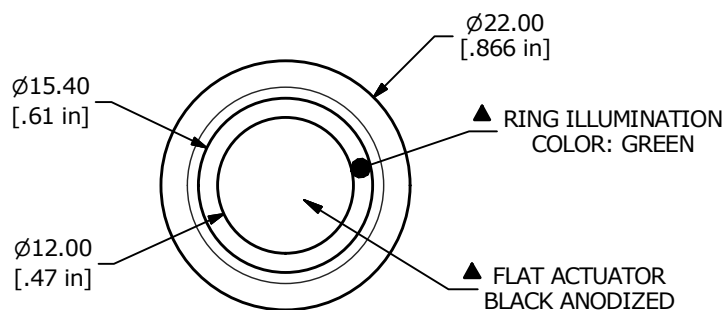
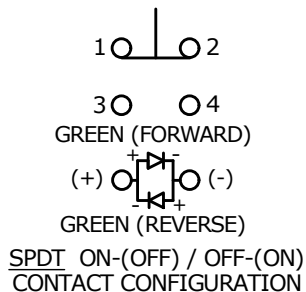

- NOTE:
- ALL DIMENSIONS IN MM [INCH]
  - GENERAL TOLERANCE: X.X = ±0.4  
X.XX = ±0.25
  - TERMINAL NUMBERS FOR REF ONLY
  - CONTACT MATERIAL: SILVER
  - RATING: 2A 24VDC
  - ELECTRIC LIFE: 50,000 MAKE-AND-BREAK CYCLES AT FULL LOAD.
  - INSULATION RESISTANCE: 1,000 MΩ MIN.
  - DIELECTRIC STRENGTH: 2,000 VAC MIN. FOR 1 MINUTE
  - CONTACT RESISTANCE: 50mΩ MAX. @ 1A 12VDC
  - OPERATING TEMP.: -20°C to 55°C
  - TRAVEL: 2.8mm
  - ▲ DENOTES CRITICAL PARAMETER
  - LAMP VOLTAGE: 2.8V
  - INGRESS PROTECTION: IP65
  - HARDWARE SUPPLIED: O-RING AND HEXNUT
  - 2011/65/EU (ROHS) COMPLIANT



A	23307	RELEASE FOR PRODUCTION	4/18/18	MW
REV	PCR NO	DESCRIPTION	DATE	BY

TITLE PV4F6Y011-331				
SCALE 3:2	DATE 4/18/2018	DR MW	DWG 52-PV4F6Y011331	REV A

THE INFORMATION CONTAINED IN THIS DOCUMENT IS PROPRIETARY TO E-SWITCH AND IS NOT TO BE COPIED OR TRANSFERRED